

INSTALLATION INSTRUCTIONS

AUDI A6 ESTATE 2011-

AU-A6-E-C

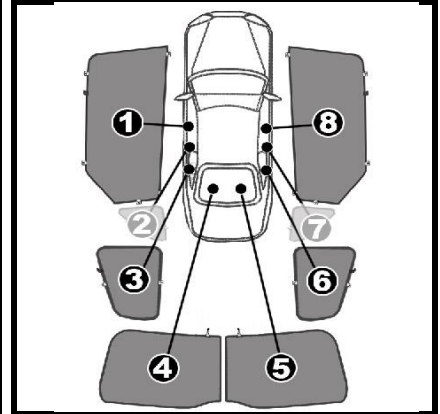

COMPONENTS INCLUDED

SHADES

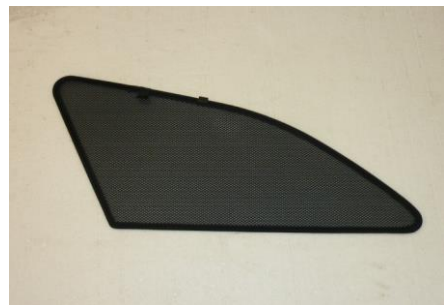

FIXING CLIPS



CL-M02 x2



CL-M12 x8



CL-P14 x1

SIDE SHADE INSTALLATION

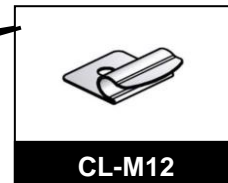

QUARTER LIGHT SHADE INSTALLATION

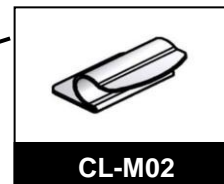

CL-M02

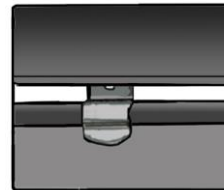

REAR SHADE INSTALLATION

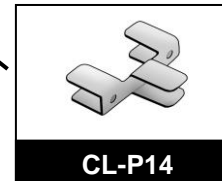
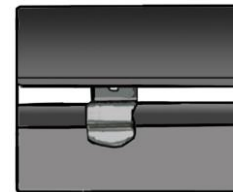
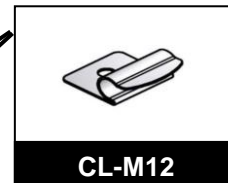
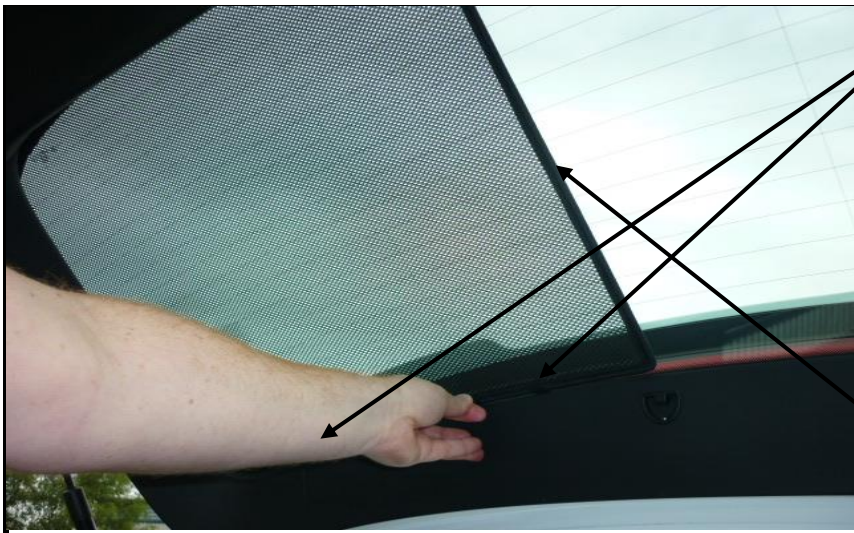

Repeat the above steps on the opposite side rear to complete.

REAR SHADE INSTALLATION

