

INSTALLATION INSTRUCTIONS

AUDI Q3 5 DOOR

AU-Q3-5-A

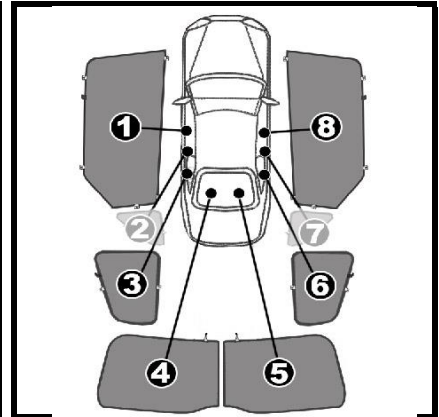

COMPONENTS INCLUDED

SHADES

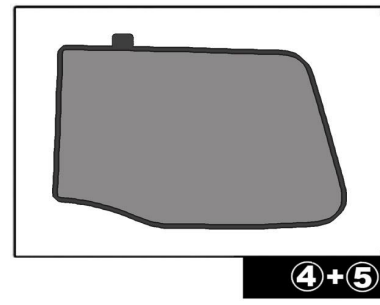
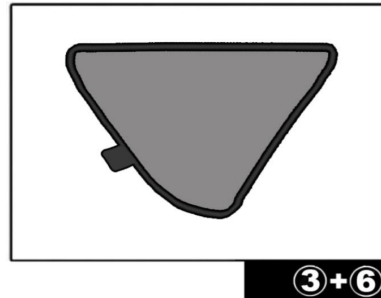
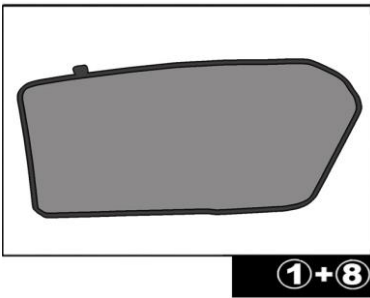

FIXING CLIPS

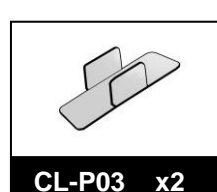
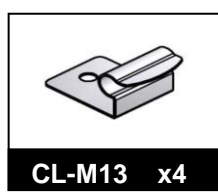
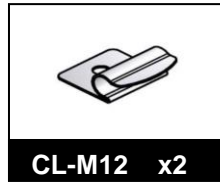
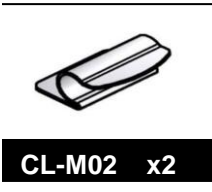

SIDE SHADE INSTALLATION

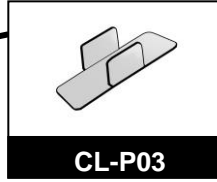
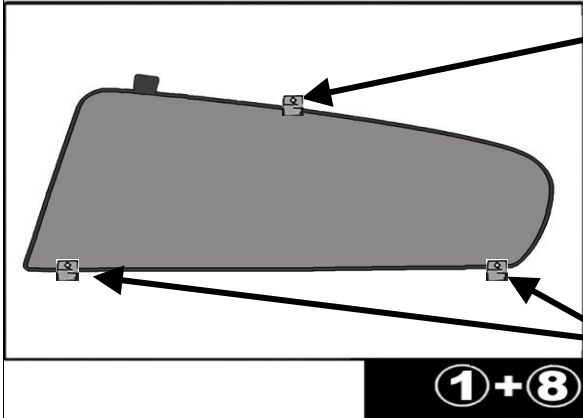

CL-P03

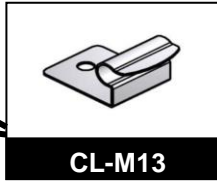

CL-M13

Ensure the surface is cleaned with the surface cleaner provided and is dry before sticking.

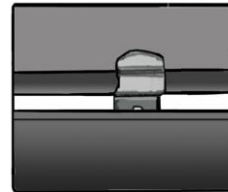

QUARTER LIGHT SHADE INSTALLATION

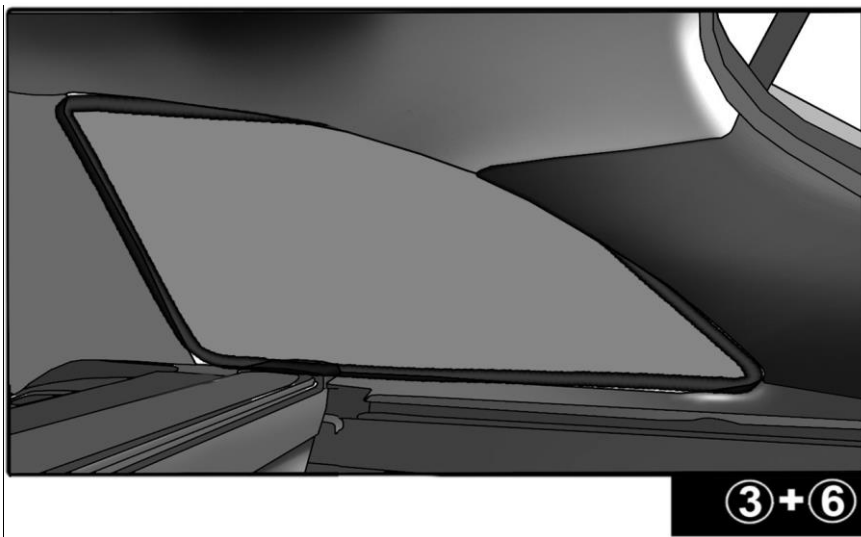
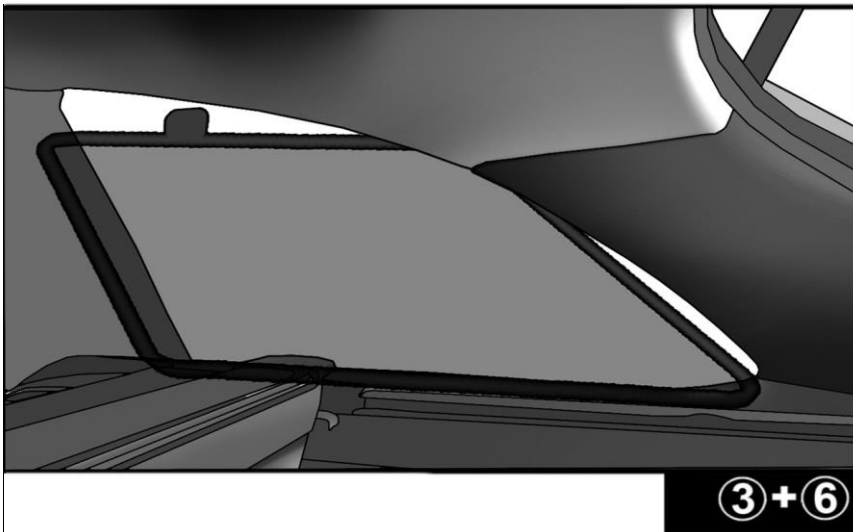
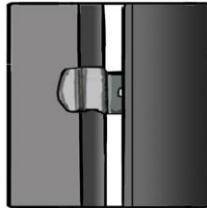
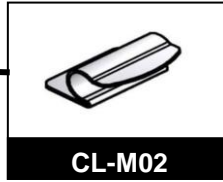
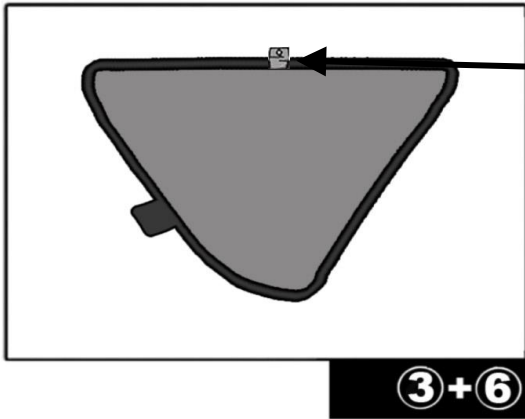

REAR SHADE INSTALLATION

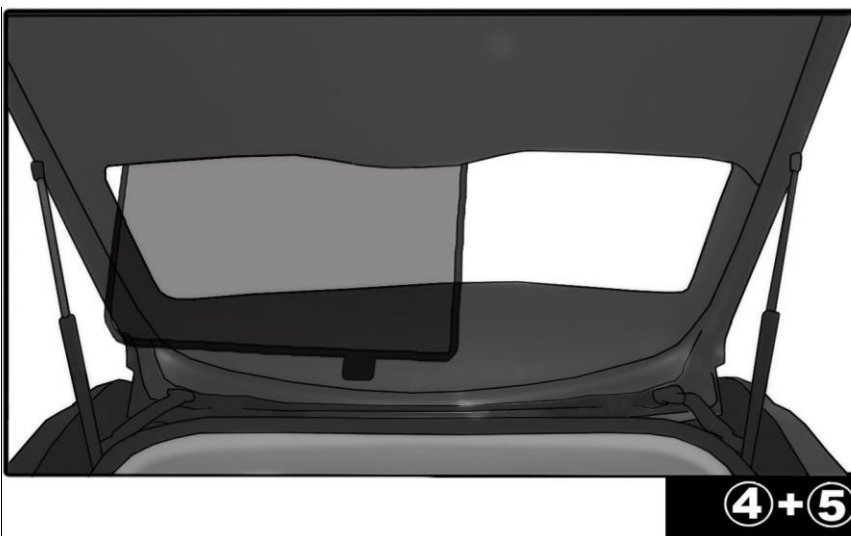
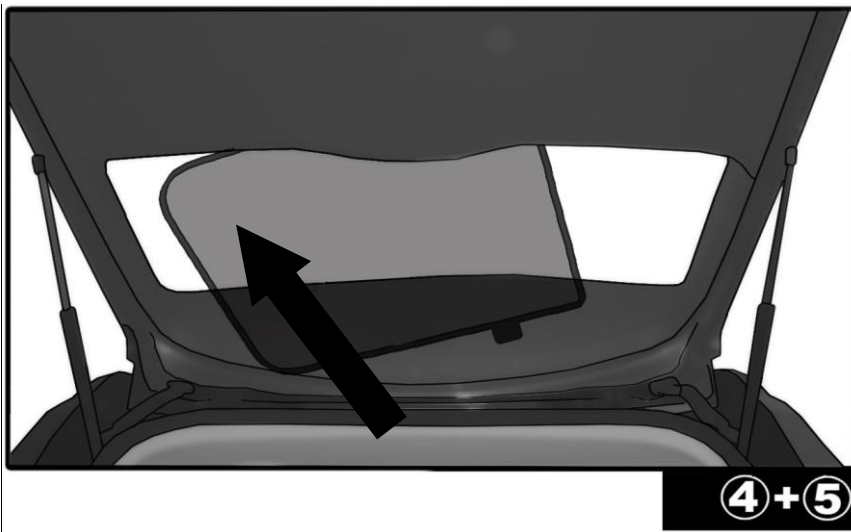
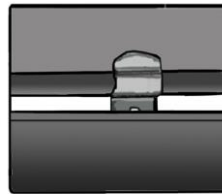
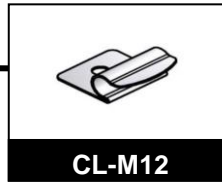
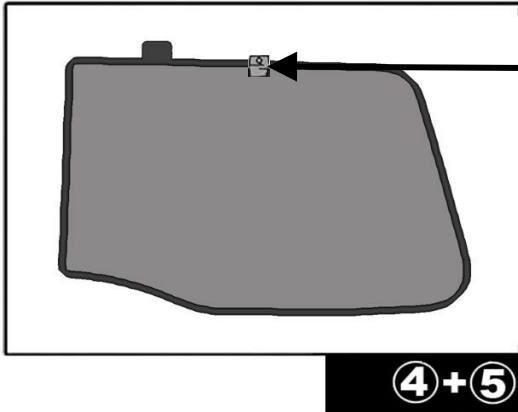

REAR SHADE INSTALLATION

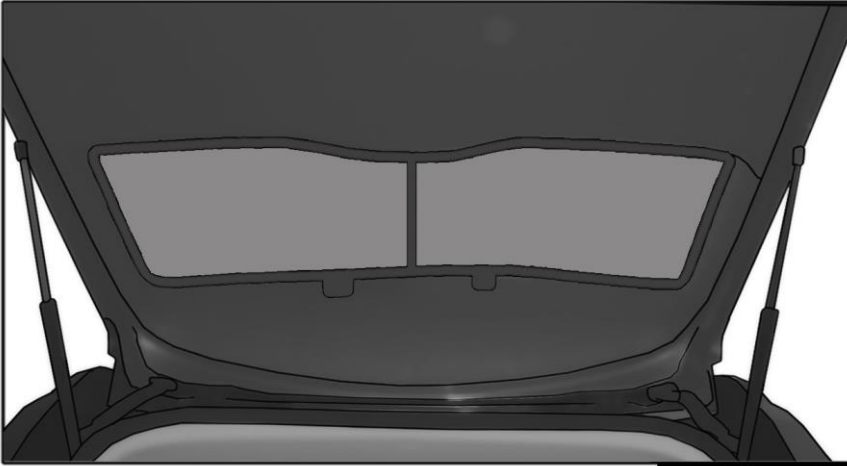

④+⑤

